

CRUISE CONTROL SYSTEM (DIAGNOSTICS)

Basic Diagnostic Procedure

CRUISE CONTROL SYSTEM (DIAGNOSTICS)

1. Basic Diagnostic Procedure

A: PROCEDURE

Step	Check	Yes	No	
1	CHECK MALFUNCTION INDICATOR LIGHT. Check the malfunction indicator light illuminates.	Does the malfunction indicator light illuminate?	Go to step 5.	Go to step 2.
2	CHECK CRUISE INDICATOR LIGHT. Check the cruise indicator light blinks.	Does the cruise indicator light blink?	Go to step 5.	Go to step 3.
3	CHECK CRUISE CONTROL MAIN SWITCH OPERATION. Check the cruise control main switch operation. (Check the cruise indicator light illuminates.)	Is the cruise control main switch set to on? (Does the cruise indicator light illuminate?)	Go to step 4.	Go to phenomenon 1. <Ref. to CC(ETC)(diag)-12, DIAGNOSTIC PROCEDURE WITH PHENOMENON, Diagnostics with Phenomenon.>
4	CHECK CRUISE CONTROL SET OPERATION. Check the cruise control set operation.	Can the cruise control be set while driving at 40 km/h (25 MPH)?	Go to step 6.	Go to step 5.
5	PERFORM CRUISE CONTROL CANCEL CONDITION DIAGNOSIS. Perform the cruise control cancel condition diagnosis.	Are any DTC indicated?	Go to "List of DTC". <Ref. to CC(ETC)(diag)-19, List of Diagnostic Trouble Code (DTC).>	Go to phenomenon 2. <Ref. to CC(ETC)(diag)-12, DIAGNOSTIC PROCEDURE WITH PHENOMENON, Diagnostics with Phenomenon.>
6	CHECK CRUISE SET INDICATOR LIGHT. Check the cruise set indicator light illuminates.	Does the cruise set indicator light illuminate?	Go to step 7.	Go to phenomenon 3. <Ref. to CC(ETC)(diag)-12, DIAGNOSTIC PROCEDURE WITH PHENOMENON, Diagnostics with Phenomenon.>
7	CHECK VEHICLE SPEED IS HELD WITHIN SET SPEED. Make sure the vehicle speed is held within set speed.	Is the vehicle speed held within set speed ± 3 km/h (± 2 MPH)?	Go to step 8.	Go to phenomenon 4. <Ref. to CC(ETC)(diag)-12, DIAGNOSTIC PROCEDURE WITH PHENOMENON, Diagnostics with Phenomenon.>
8	CHECK RES/ACC OPERATION. Check the RES/ACC switch operation.	Does the vehicle speed increase or return to set speed after RES/ACC switch has been pressed?	Go to step 9.	Go to phenomenon 5. <Ref. to CC(ETC)(diag)-12, DIAGNOSTIC PROCEDURE WITH PHENOMENON, Diagnostics with Phenomenon.>

Basic Diagnostic Procedure

CRUISE CONTROL SYSTEM (DIAGNOSTICS)

Step	Check	Yes	No	
9	CHECK SET/COAST OPERATION. Check the SET/COAST switch operation.	Does the vehicle speed decrease after SET/COAST switch has been pressed?	Go to step 10 .	Go to phenomenon 6. <Ref. to CC(ETC)(diag)-12, DIAGNOSTIC PROCEDURE WITH PHENOMENON, Diagnostics with Phenomenon.>
10	CHECK CANCEL OPERATION. Check the CANCEL switch operation.	Is the cruise control released after CANCEL switch has been pressed?	Go to step 11 .	Go to phenomenon 7. <Ref. to CC(ETC)(diag)-12, DIAGNOSTIC PROCEDURE WITH PHENOMENON, Diagnostics with Phenomenon.>
11	CHECK CRUISE CONTROL RELEASE OPERATION. Check the cruise control release operation.	Is the cruise control released after brake pedal has been depressed?	<ul style="list-style-type: none"> • Go to step 12. (MT model) • Finish the diagnosis. (AT model) 	Go to phenomenon 8. <Ref. to CC(ETC)(diag)-12, DIAGNOSTIC PROCEDURE WITH PHENOMENON, Diagnostics with Phenomenon.>
12	CHECK CRUISE CONTROL RELEASE OPERATION. Check the cruise control release operation.	Is the cruise control released after clutch pedal has been depressed? (MT model)	Go to step 13 .	Go to phenomenon 9. <Ref. to CC(ETC)(diag)-12, DIAGNOSTIC PROCEDURE WITH PHENOMENON, Diagnostics with Phenomenon.>
13	CHECK CRUISE CONTROL RELEASE OPERATION. Check the cruise control release operation.	Is the cruise control released after shifting to neutral position? (MT model)	Finish the diagnosis.	Go to phenomenon 10. <Ref. to CC(ETC)(diag)-12, DIAGNOSTIC PROCEDURE WITH PHENOMENON, Diagnostics with Phenomenon.>

General Description

CRUISE CONTROL SYSTEM (DIAGNOSTICS)

2. General Description

A: CAUTION

1. SUPPLEMENTAL RESTRAINT SYSTEM “AIRBAG”



Airbag system wiring harness is routed near the cruise control switch.

CAUTION:

- Airbag system connectors are colored yellow. Do not use electrical test equipment on these circuits.
- Be careful not to damage the airbag system wiring harness when servicing the cruise control switch.

B: PREPARATION TOOL

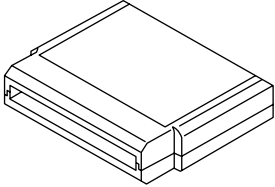
1. SPECIAL TOOL

ILLUSTRATION	TOOL NUMBER	DESCRIPTION	REMARKS
 ST18482AA010	18482AA010 (Newly adopted tool)	CARTRIDGE	Troubleshooting for electrical systems.
 ST22771AA030	22771AA030	SUBARU SELECT MONITOR KIT	Troubleshooting for electrical systems.

2. GENERAL TOOL

TOOL NAME	REMARKS
Circuit tester	Used for measuring resistance, voltage and ampere.

C: INSPECTION

1. BATTERY

Measure the battery voltage and specific gravity of electrolyte.

Standard voltage:

12 V, or more

Specific gravity:

Above 1.260

Electrical Component Location

CRUISE CONTROL SYSTEM (DIAGNOSTICS)

3. Electrical Component Location

A: LOCATION

1. NON-TURBO MODEL

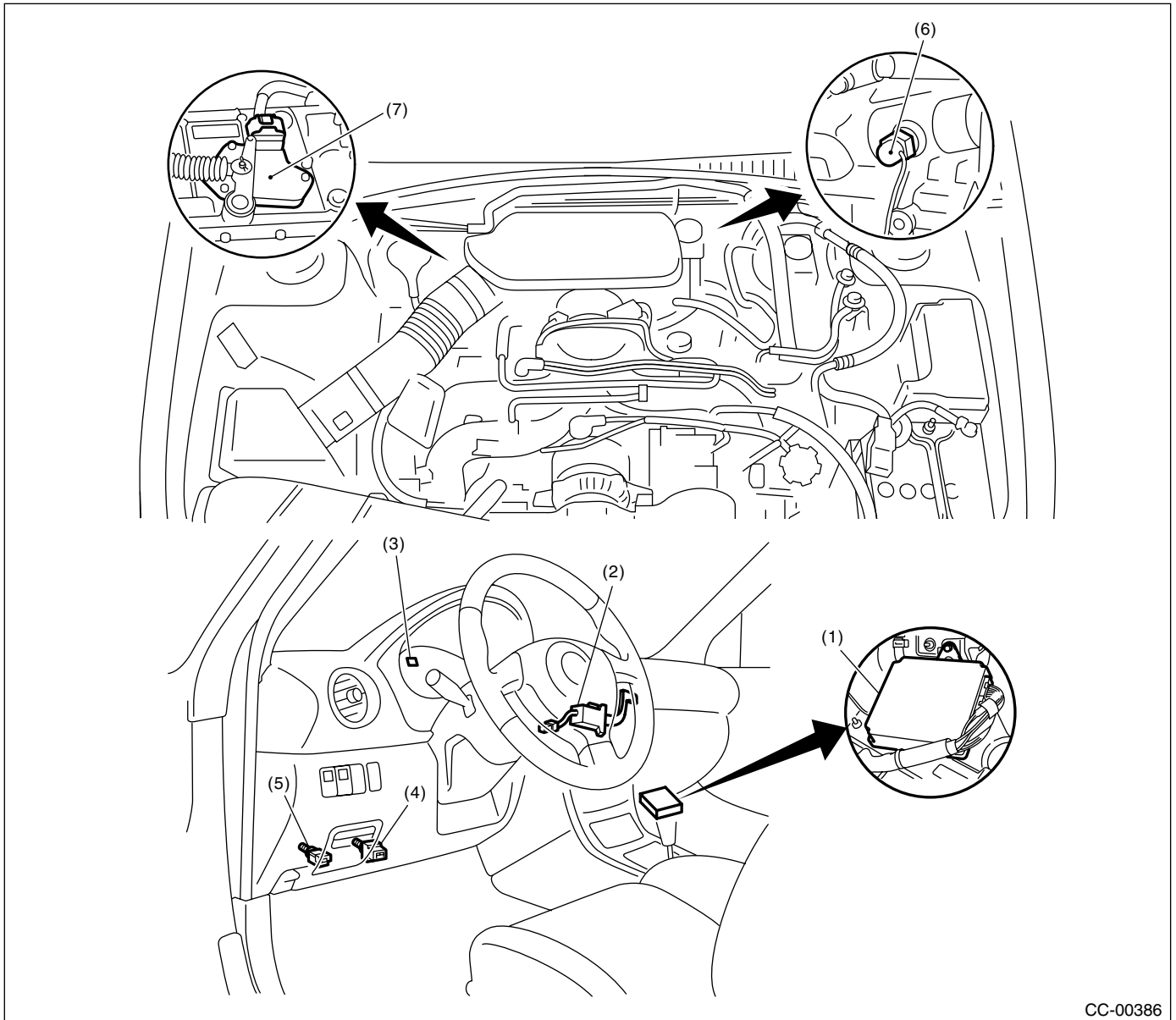

CC-00386

- | | | |
|---|---|---------------------------------|
| (1) Engine control module (ECM) | (3) Cruise indicator light & cruise set indicator light | (5) Clutch switch (MT model) |
| (2) Cruise control command switch (with built-in main switch) | (4) Stop light & brake switch | (6) Neutral position switch |
| | | (7) Inhibitor switch (AT model) |

Electrical Component Location

CRUISE CONTROL SYSTEM (DIAGNOSTICS)

2. TURBO MODEL

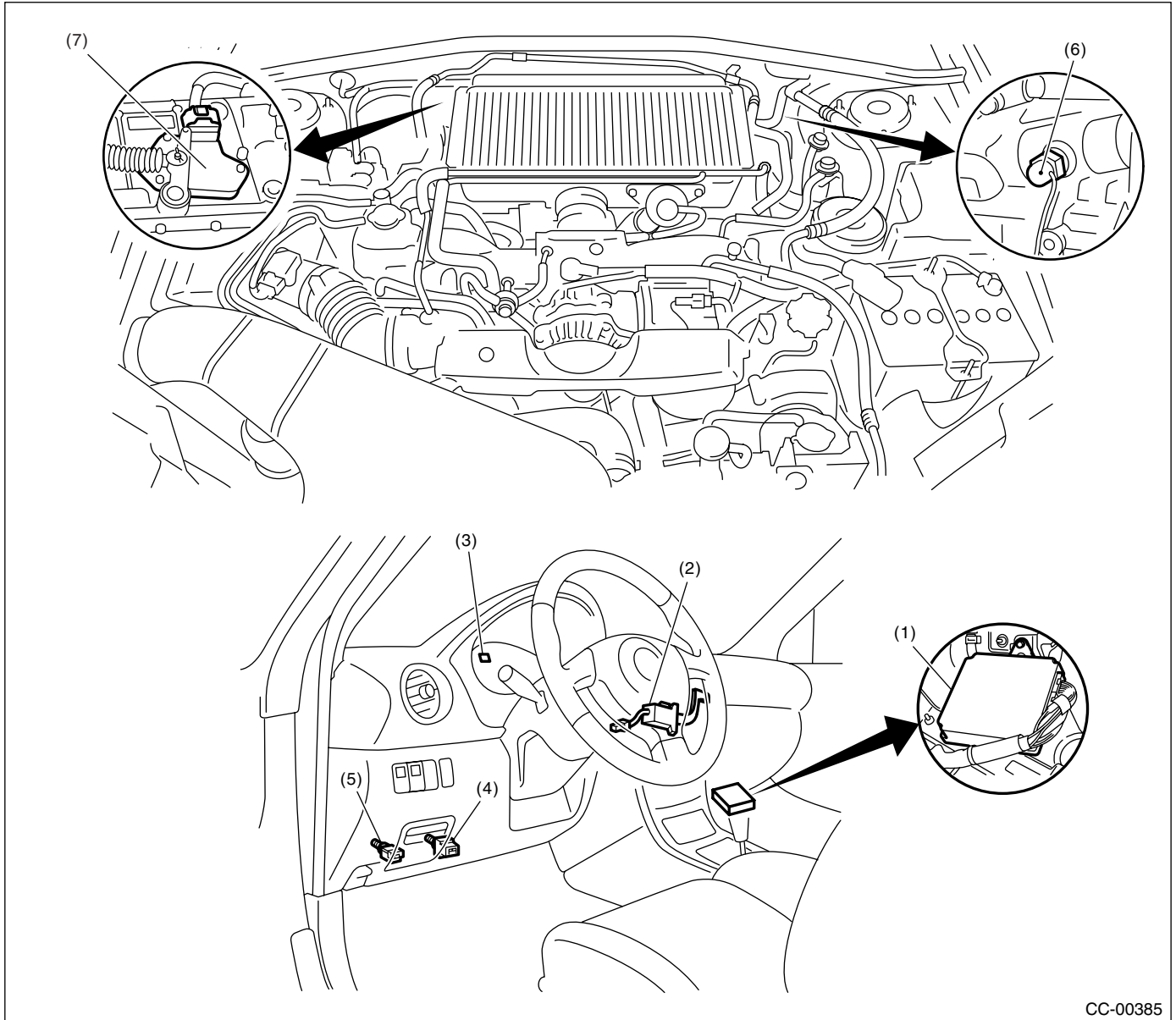

CC-00385

- | | | |
|--|---|--|
| (1) Engine control module (ECM) | (3) Cruise indicator light and cruise set indicator light | (5) Clutch switch (MT model) |
| (2) Cruise control command switch (main switch built-in) | (4) Stop light and brake switch | (6) Neutral position switch (MT model) |

Electrical Component Location

CRUISE CONTROL SYSTEM (DIAGNOSTICS)

3. STI MODEL

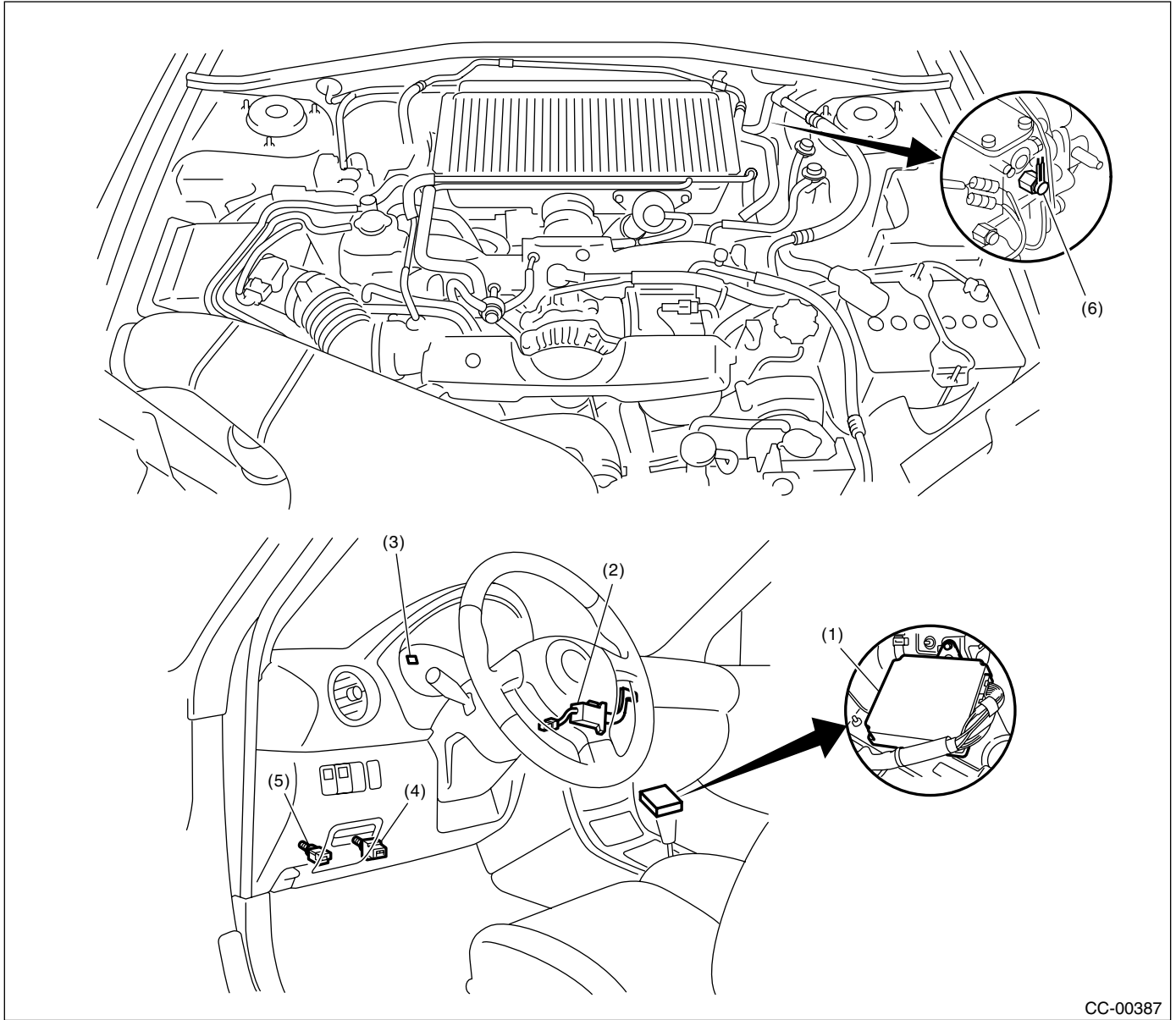

CC-00387

- | | | |
|---|---|------------------------------|
| (1) Engine control module (ECM) | (3) Cruise indicator light & cruise set indicator light | (5) Clutch switch (MT model) |
| (2) Cruise control command switch (with built-in main switch) | (4) Stop light & brake switch | (6) Neutral position switch |

Engine Control Module (ECM) I/O Signal

CRUISE CONTROL SYSTEM (DIAGNOSTICS)

4. Engine Control Module (ECM) I/O Signal

A: ELECTRICAL SPECIFICATION

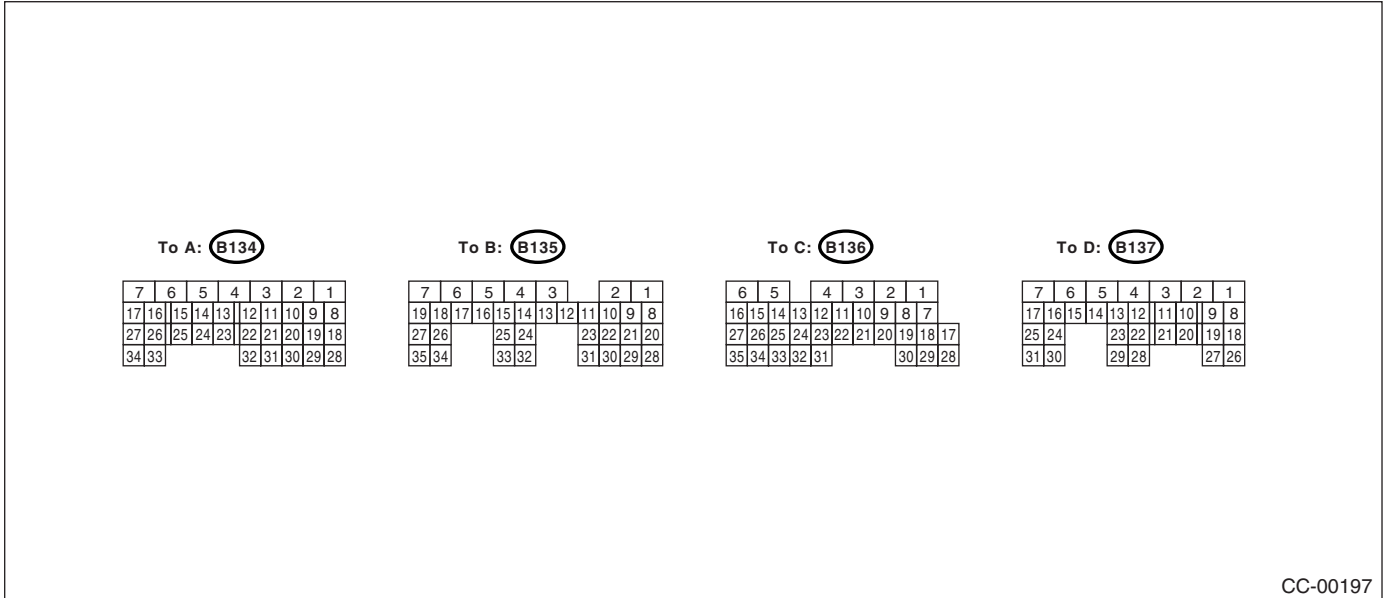

CC-00197

Content		Terminal No.	Measuring condition and I/O signal (ignition switch ON and engine idling Except cruise set light)
Clutch switch		Except STI model: C25 STI model: A1	<ul style="list-style-type: none"> Battery voltage is present when the clutch pedal is released. "0" volt is present when the clutch pedal is depressed.
Cruise set indicator light		Except STI model: B3 STI model: A16	(Press the main switch and drive the vehicle at 40 km/h (25 MPH) or more.) <ul style="list-style-type: none"> Battery voltage is present when the set switch is turned to OFF. "0" volt is present when the set switch is turned to ON.
Cruise indicator light		Except STI model: B6 STI model: A15	<ul style="list-style-type: none"> Battery voltage is present when the main switch is turned to OFF. "0" volt is present when the main switch is turned to ON.
Main power supply	VB (CONTROL 1) VB (CONTROL 2)	Except STI model: B5 STI model: B19	Battery voltage is present.
Vehicle speed signal		Non-turbo model: C12 Turbo model: C13 STI model: B26	Lift-up the vehicle until all four wheels are raised off the ground, and then rotate any wheel manually. Approx. "5 V" and "0 V" pulse signals are alternately input to ECM.
SET/COAST switch		Except STI model: B24 STI model: C11	<ul style="list-style-type: none"> Battery voltage is present when the cruise control command switch is turned to SET/COAST position. "0" volt is present when the cruise control command switch is released.
RES/ACC switch		Except STI model: B13 STI model: C10	<ul style="list-style-type: none"> Battery voltage is present when the cruise control command switch is turned to RES/ACC position. "0" volt is present when the cruise control command switch is released.
Brake switch 1 (Brake switch)		Except STI model: B20 STI model: C9	<ul style="list-style-type: none"> Battery voltage is present when the brake pedal is released. "0" volt is present when the brake pedal is depressed.
Brake switch 2 (Stop light switch)		Except STI model: B28 STI model: C8	<ul style="list-style-type: none"> Battery voltage is present when the brake pedal is depressed. "0" volt is present when the brake pedal is released.
Cruise control main switch		Except STI model: B12 STI model: C7	<ul style="list-style-type: none"> Battery voltage is present while the cruise control main switch is depressed or is turned to ON. "0" volt is present when the cruise control main switch is turned to OFF.

Engine Control Module (ECM) I/O Signal

CRUISE CONTROL SYSTEM (DIAGNOSTICS)

Content		Terminal No.	Measuring condition and I/O signal (ignition switch ON and engine idling Except cruise set light)
Ground	GND (CONTROL 1)	Except STI model: C15 STI model: D2	—
	GND (CONTROL 2)	Except STI model: A5 STI model: D1	—
Ignition switch		Non-turbo model: B27 Turbo model: B19 STI model: D14	<ul style="list-style-type: none"> • Battery voltage is present with the ignition switch is turned to ON. • "0" volt is present when the ignition switch is turned to OFF.
Neutral position switch (MT model)		Except STI model: C31 STI model: D9	<ul style="list-style-type: none"> • Battery voltage is present when the shift lever is in anywhere except neutral position. • "0" volt is present when the shift lever is in neutral position.
Neutral signal (AT model)		C31	<ul style="list-style-type: none"> • "Approx. 5 V" voltage (4AT model) or battery voltage (5AT model) is present when the shift lever is set in any position except "P" or "N". • "0 V" voltage is present when the shift lever is set in "P" or "N" position.

B: WIRING DIAGRAM

<Ref. to WI-102, WIRING DIAGRAM, Cruise Control System.>

Subaru Select Monitor

CRUISE CONTROL SYSTEM (DIAGNOSTICS)

5. Subaru Select Monitor

A: OPERATION

1. GENERAL

The on-board diagnosis function of the cruise control system uses the Subaru Select Monitor.

The on-board diagnosis function operates in two categories, which are used depending on the type of problems;

1) Cruise cancel conditions diagnosis:

(1) This category of diagnosis requires actual vehicle driving in order to determine the cause, (as when cruise speed is cancelled during driving although cruise cancel condition is not entered).

(2) Cruise control memory of ECM stores the cancel condition (Code No.) which occurred during driving. When there are plural cancel conditions (Code No.), they are shown on the Subaru Select Monitor.

CAUTION:

- The cruise control memory stores not only the cruise “cancel” which occurred (although “cancel” operation is not entered by the driver), but also the “cancel” condition input by the driver.

- The content of memory is cleared when ignition switch or cruise control main switch is turned OFF.

2) Real-time diagnosis:

The real-time diagnosis function is used to determine whether or not the input signal system is in good order, according to signal emitted from switches, sensors, etc.

(1) Vehicle cannot be driven at cruise speed because problem occurs in the cruise control system or its associated circuits.

(2) Monitor the signal conditions from switches and sensors.

2. CRUISE CANCEL CONDITIONS DIAGNOSIS

1) Prepare the Subaru Select Monitor kit.

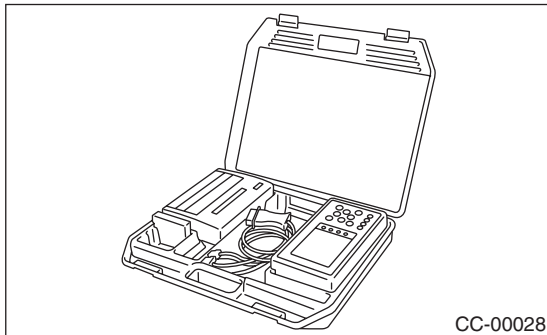

2) Connect the diagnosis cable to Subaru Select Monitor.

3) Insert the cartridge into Subaru Select Monitor. <Ref. to CC(ETC)(diag)-4, SPECIAL TOOL, PREPARATION TOOL, General Description.>

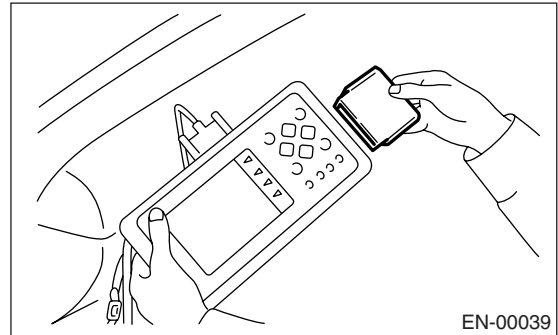

4) Connect the Subaru Select Monitor to data link connector.

(1) Data link connector is located in the lower portion of the instrument panel (on the driver's side).

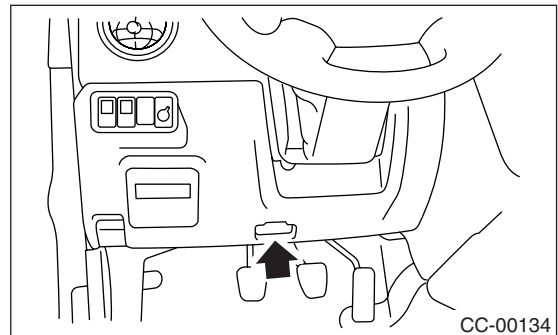

(2) Connect the diagnosis cable to data link connector.

5) Start the engine and turn the cruise control main switch to ON.

6) Turn the Subaru Select Monitor power switch to ON.

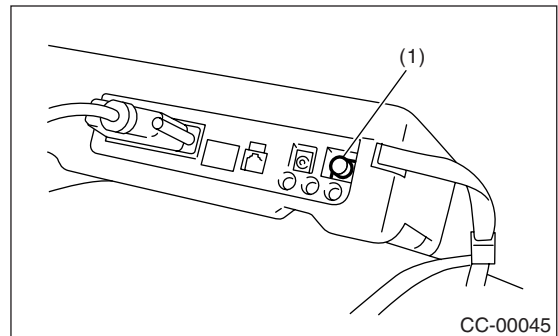

(1) Power switch

7) On the Main Menu display screen, select the {2. Each System Diagnosis} and press [YES] key. Select the {Engine} on the System Selection display screen and press [YES] key. Press [YES] key after the engine type displayed.

8) Drive the vehicle at least 40 km/h (25 MPH) with cruise speed set.

9) If the cruise speed is canceled itself (without doing any cancel operations), a DTC will appear on the display after {Cancel Code(s) Display} is selected on the Engine Diagnosis display screen and [YES] key is pressed.

CAUTION:

- **When performing diagnostics, observe the legal speed of the road.**
- **A DTC will also appear when cruise cancel is effected by driver. Do not confuse.**
- **Have a co-worker ride in the vehicle to assist in diagnosis during driving.**

NOTE:

DTC will be cleared by turning the ignition switch or cruise control main switch to OFF.

3. REAL-TIME DIAGNOSIS

- 1) Connect the select monitor.
- 2) Turn the ignition switch and cruise control main switch to ON.
- 3) Turn the Subaru Select Monitor power switch to ON.
- 4) On the Main Menu display screen, select the {2. Each System Check} and press [YES] key.
- 5) On the System Selection display screen, select the {Engine} and press [YES] key.
- 6) Press the [YES] key after the information of engine type has been displayed.
- 7) On the Cruise Control Diagnosis display screen, select the {Current Data Display & Save} and press [YES] key.
- 8) Make sure that normal indication is displayed when operated as indicated below:
 - Depress/release the brake pedal. (Stop light switch and brake switch turn ON.)
 - Turn ON the "SET/COAST" switch.
 - Turn ON the "RES/ACC" switch.
 - Turn ON the "CANCEL" switch. (The "SET/COAST" and "RES/ACC" switch are turned ON at same time.)
 - Depress/release the clutch pedal. (MT model)
 - Set the shift lever to any position other than neutral. (MT model)
 - Place the select lever in any position other than "P" or "N". (AT model)

NOTE:

- For detailed operation procedure, refer to the SUBARU SELECT MONITOR OPERATION MANUAL.
- For details concerning DTCs, refer to the List of DTC. <Ref. to CC(ETC)(diag)-19, List of Diagnostic Trouble Code (DTC).>

Diagnostics with Phenomenon

CRUISE CONTROL SYSTEM (DIAGNOSTICS)

6. Diagnostics with Phenomenon

A: DIAGNOSTIC PROCEDURE WITH PHENOMENON

Phenomenon		Checking item	Reference
1	Cruise control main switch is not turned to ON. (Cruise indicator light does not illuminate)	(1) Check the cruise indicator light.	<Ref. to CC(ETC)(diag)-13, CHECK CRUISE INDICATOR LIGHT, Diagnostics with Phenomenon.>
		(2) Check the cruise control command switch.	<Ref. to CC(ETC)(diag)-22, DTC 11, 15, 21 AND 24 CRUISE CONTROL COMMAND SWITCH, Diagnostic Procedure with Diagnostic Trouble Code (DTC).>
2	Cruise control cannot be set.	(1) Check the cruise control command switch	<Ref. to CC(ETC)(diag)-22, DTC 11, 15, 21 AND 24 CRUISE CONTROL COMMAND SWITCH, Diagnostic Procedure with Diagnostic Trouble Code (DTC).>
		(2) Check the stop light and brake switch.	<Ref. to CC(ETC)(diag)-25, DTC 12 AND 25 STOP LIGHT SWITCH AND BRAKE SWITCH, Diagnostic Procedure with Diagnostic Trouble Code (DTC).>
		(3) Check the clutch switch. (MT model)	<Ref. to CC(ETC)(diag)-27, DTC 13 CLUTCH SWITCH, Diagnostic Procedure with Diagnostic Trouble Code (DTC).>
		(4) Check the neutral position switch.	<Ref. to CC(ETC)(diag)-29, DTC 14 NEUTRAL POSITION SWITCH, Diagnostic Procedure with Diagnostic Trouble Code (DTC).>
		(5) Check the vehicle speed sensor. (MT model)	<Ref. to CC(ETC)(diag)-35, DTC 22 AND 32 VEHICLE SPEED SENSOR, Diagnostic Procedure with Diagnostic Trouble Code (DTC).>
3	Cruise set indicator light does not illuminate.	Check the cruise set indicator light.	<Ref. to CC(ETC)(diag)-16, CHECK CRUISE SET INDICATOR LIGHT, Diagnostics with Phenomenon.>
4	Vehicle speed is not held within set speed ± 3 km/h (± 2 MPH).	Check the vehicle speed sensor.	<Ref. to CC(ETC)(diag)-35, DTC 22 AND 32 VEHICLE SPEED SENSOR, Diagnostic Procedure with Diagnostic Trouble Code (DTC).>
5	Vehicle speed does not increase or does not return to set speed after RES/ACC switch has been pressed.	Check the RES/ACC switch.	<Ref. to CC(ETC)(diag)-22, DTC 11, 15, 21 AND 24 CRUISE CONTROL COMMAND SWITCH, Diagnostic Procedure with Diagnostic Trouble Code (DTC).>
6	Vehicle speed does not decrease after SET/COAST switch has been pressed.	Check the SET/COAST switch.	<Ref. to CC(ETC)(diag)-22, DTC 11, 15, 21 AND 24 CRUISE CONTROL COMMAND SWITCH, Diagnostic Procedure with Diagnostic Trouble Code (DTC).>
7	Cruise control is not released after CANCEL switch has been pressed.	Check the CANCEL switch.	<Ref. to CC(ETC)(diag)-22, DTC 11, 15, 21 AND 24 CRUISE CONTROL COMMAND SWITCH, Diagnostic Procedure with Diagnostic Trouble Code (DTC).>
8	Cruise control is not released after the brake pedal has been depressed.	Check the stop light and brake switch.	<Ref. to CC(ETC)(diag)-25, DTC 12 AND 25 STOP LIGHT SWITCH AND BRAKE SWITCH, Diagnostic Procedure with Diagnostic Trouble Code (DTC).>
9	Cruise control is not released after the clutch pedal has been depressed. (MT model)	Check the clutch switch.	<Ref. to CC(ETC)(diag)-27, DTC 13 CLUTCH SWITCH, Diagnostic Procedure with Diagnostic Trouble Code (DTC).>
10	Cruise control is not released after shifting to neutral position.	Check the neutral position switch.	<Ref. to CC(ETC)(diag)-29, DTC 14 NEUTRAL POSITION SWITCH, Diagnostic Procedure with Diagnostic Trouble Code (DTC).>

Diagnostics with Phenomenon

CRUISE CONTROL SYSTEM (DIAGNOSTICS)

B: CHECK CRUISE INDICATOR LIGHT

TROUBLE SYMPTOM:

Cruise control can be set, but cruise indicator light does not illuminate.

WIRING DIAGRAM:

- Non-turbo model

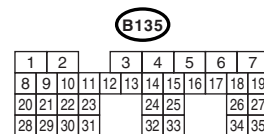
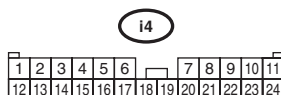
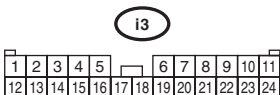
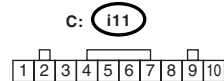
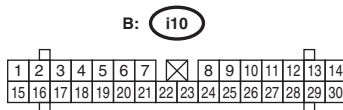
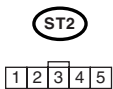
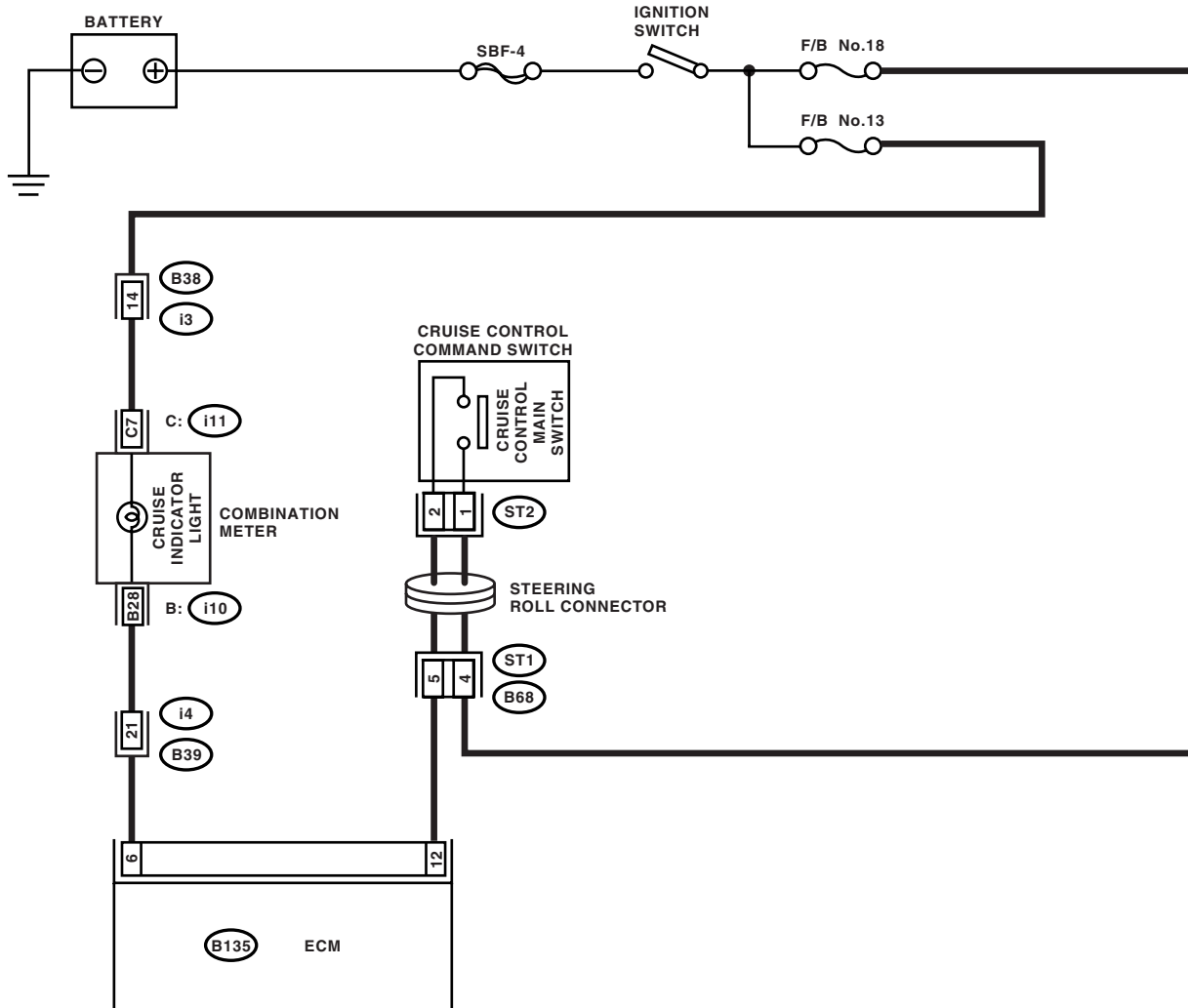

CC-00409

Diagnostics with Phenomenon

CRUISE CONTROL SYSTEM (DIAGNOSTICS)

- Turbo model and STI model

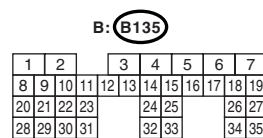
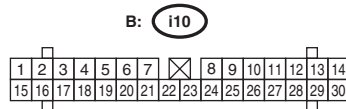
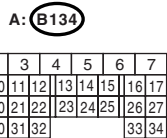
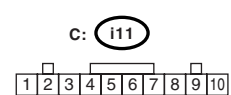
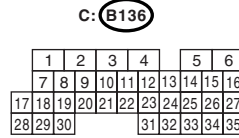
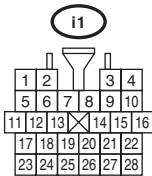
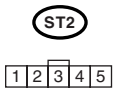
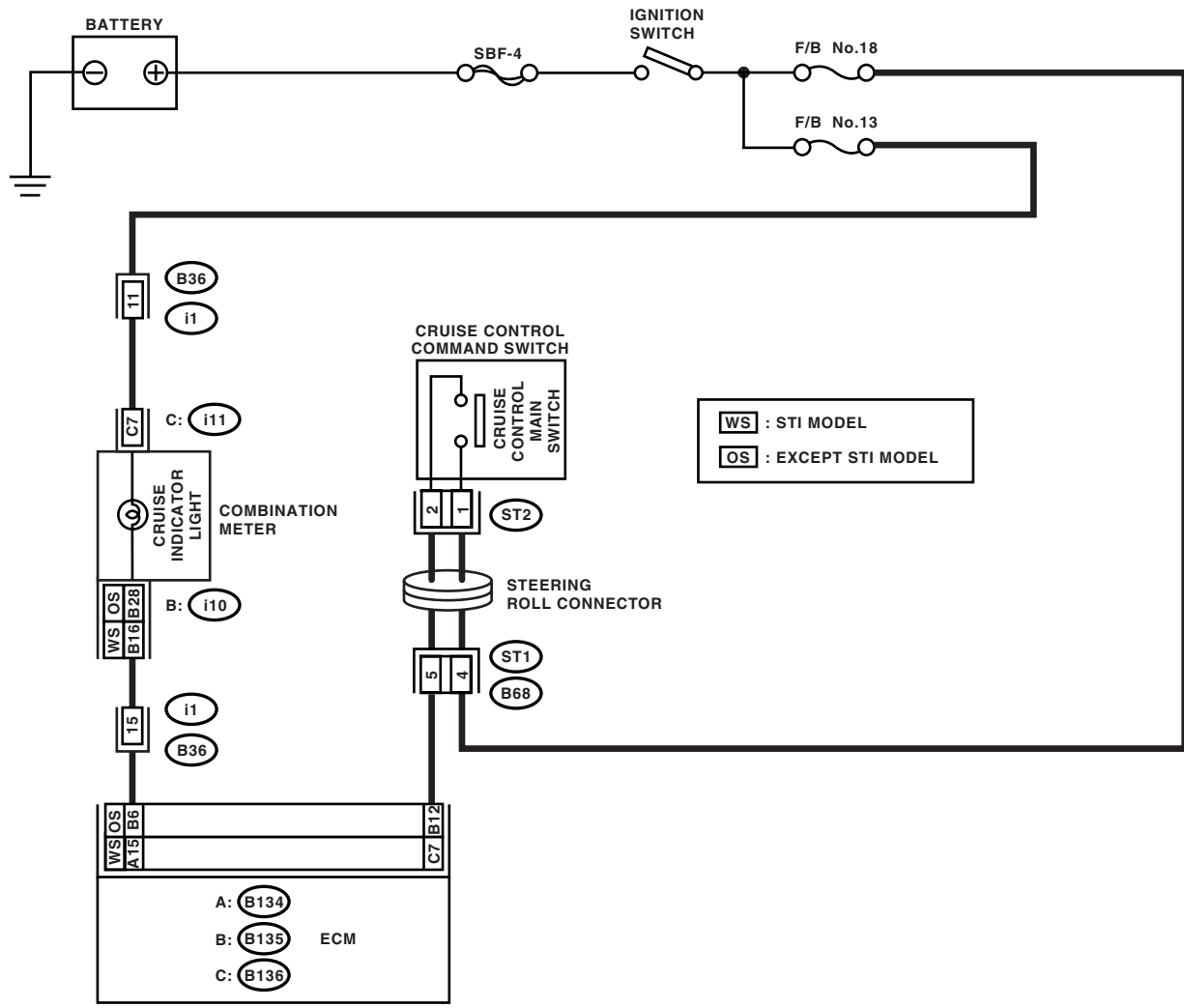

CC-00441

Diagnostics with Phenomenon

CRUISE CONTROL SYSTEM (DIAGNOSTICS)

Step	Check	Yes	No
<p>1</p> <p>CHECK CRUISE INDICATOR LIGHT CIRCUIT.</p> <p>1) Turn the ignition switch to OFF. 2) Disconnect the combination meter harness connector. 3) Turn the ignition switch to ON. 4) Measure the voltage between harness connector terminal and chassis ground.</p> <p>Connector & terminal <i>(i11) No. 7 (+) — Chassis ground (-):</i></p>	<p>Is the voltage more than 10 V?</p>	<p>Go to step 2.</p>	<ul style="list-style-type: none"> • Check the fuse No. 13 (in fuse & relay box). • Check the harness for open or short between combination meter and fuse & relay box.
<p>2</p> <p>CHECK CRUISE INDICATOR LIGHT CIRCUIT.</p> <p>1) Turn the ignition switch to OFF. 2) Disconnect the ECM harness connector. 3) Measure the resistance between ECM harness connector terminal and combination meter harness connector terminal.</p> <p>Connector & terminal Except STI model: <i>(B135) No. 6 — (i10) No. 28:</i> STI model: <i>(B134) No. 15 — (i10) No. 16:</i></p>	<p>Is the resistance less than 10 Ω?</p>	<p>Go to step 3.</p>	<p>Repair the harness.</p>
<p>3</p> <p>CHECK CRUISE INDICATOR LIGHT CIRCUIT.</p> <p>1) Turn the ignition switch to ON. 2) Ground the ECM harness connector terminal with a wire.</p> <p>Connector & terminal Except STI model: <i>(B135) No. 6 — Chassis ground:</i> STI model: <i>(B134) No. 15 — Chassis ground:</i></p>	<p>Does the cruise indicator light illuminate?</p>	<p>Check the poor contact of ECM connector.</p>	<p>Replace the meter main assembly.</p>

Diagnostics with Phenomenon

CRUISE CONTROL SYSTEM (DIAGNOSTICS)

C: CHECK CRUISE SET INDICATOR LIGHT

TROUBLE SYMPTOM:

Cruise control can be set, but cruise set indicator light does not illuminate.

WIRING DIAGRAM:

- Non-turbo model

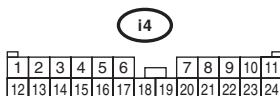
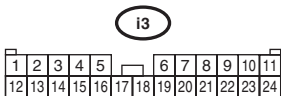
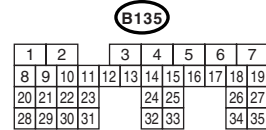
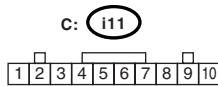
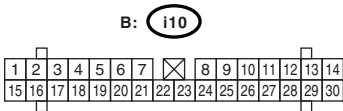
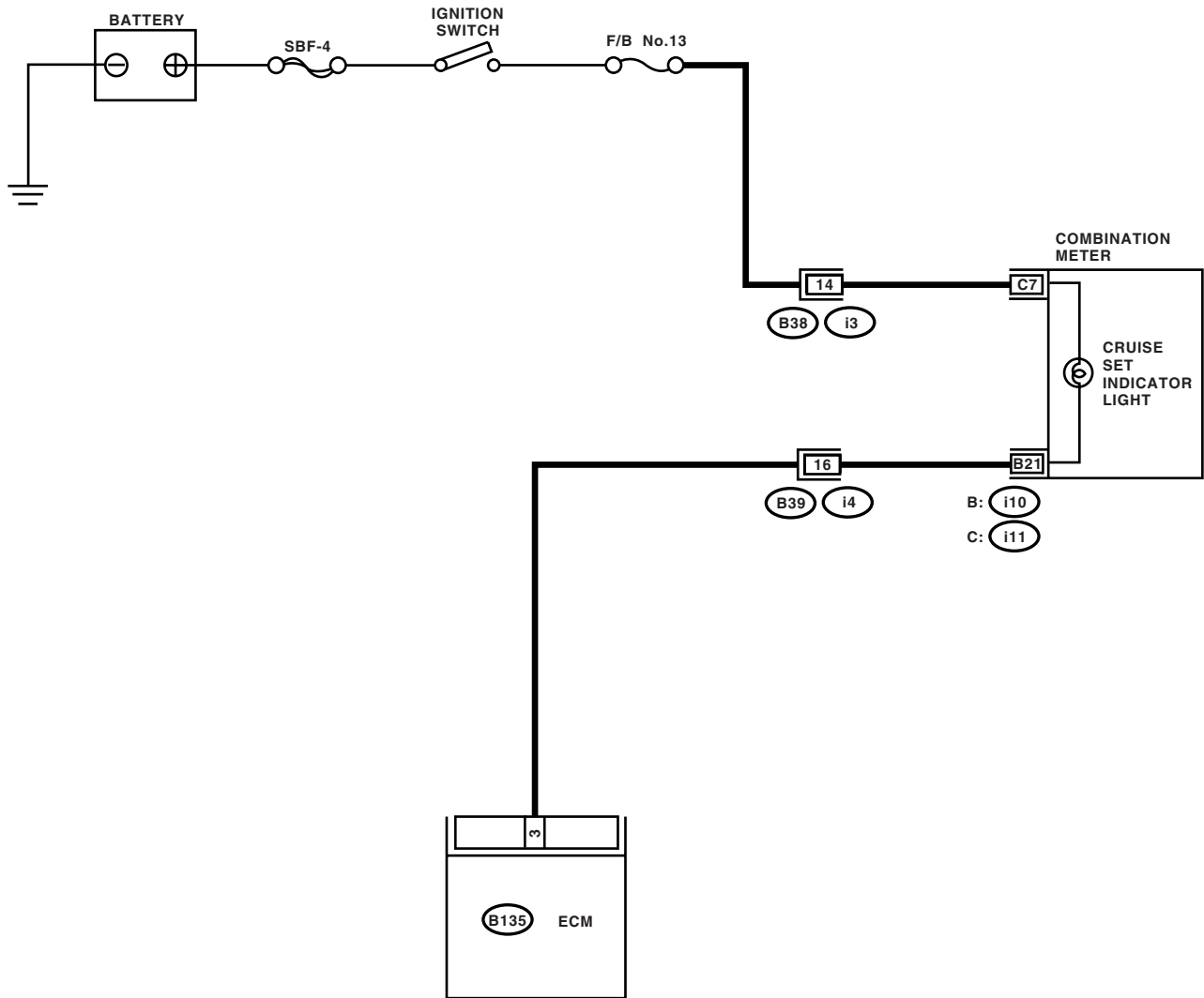

CC-00410

Diagnostics with Phenomenon

CRUISE CONTROL SYSTEM (DIAGNOSTICS)

- Turbo model and STI model

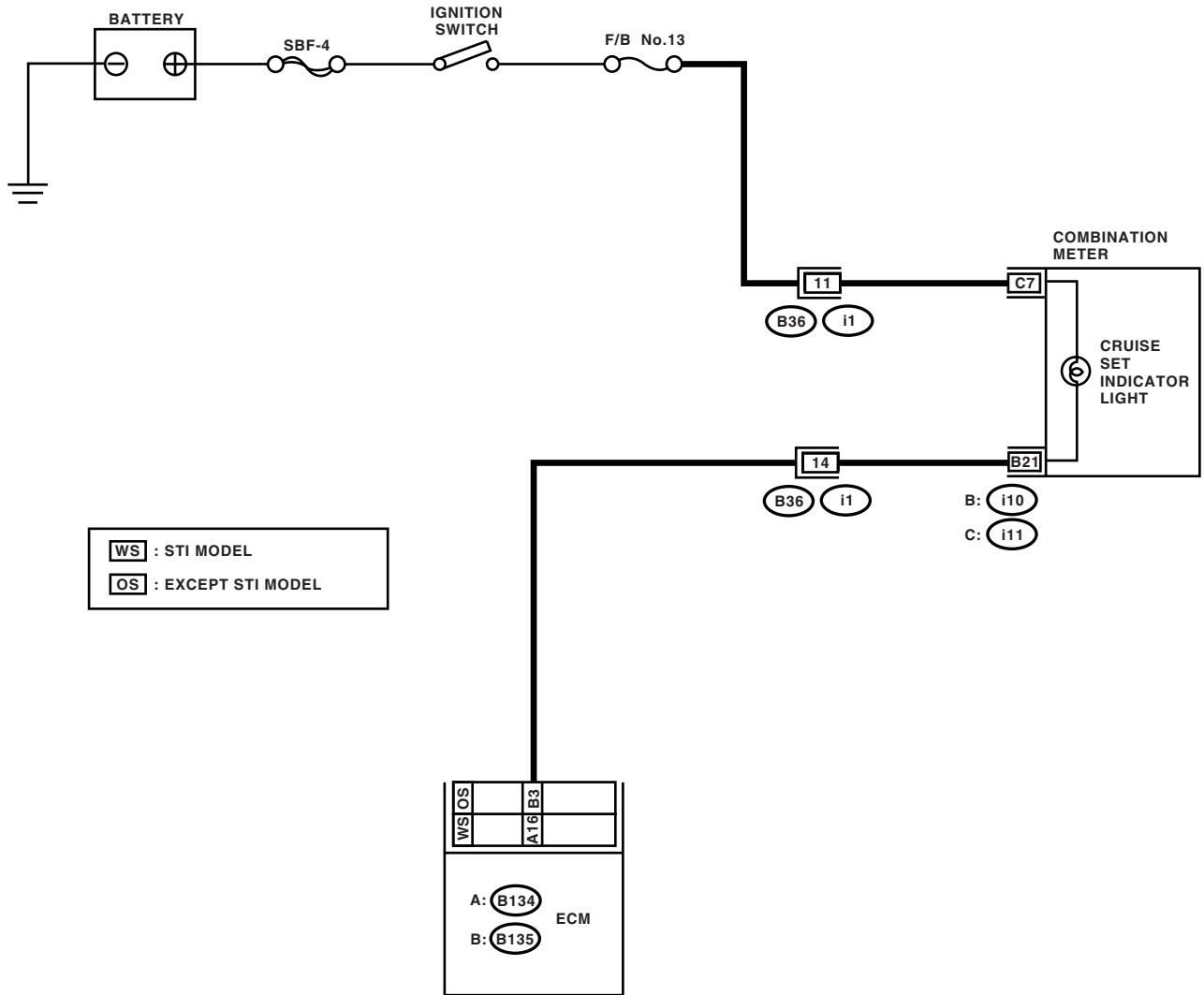

A: (B134)

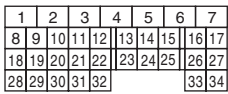

B: (i10)

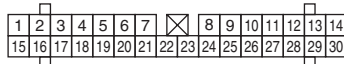

B: (B135)

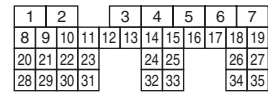

C: (i11)

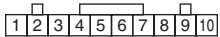

i1

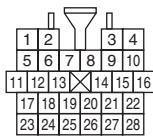

CC-00442

Diagnostics with Phenomenon

CRUISE CONTROL SYSTEM (DIAGNOSTICS)

Step	Check	Yes	No
1 CHECK CRUISE SET INDICATOR LIGHT CIRCUIT. 1) Turn the ignition switch to OFF. 2) Disconnect the combination meter harness connector. 3) Measure the voltage between harness connector terminal and chassis ground. Connector & terminal <i>(i11) No. 7 (+) — Chassis ground (-):</i>	Is the voltage more than 10 V?	Go to step 2.	<ul style="list-style-type: none"> • Check the fuse No. 13 (in fuse & relay box). • Check the harness for open or short between combination meter and fuse & relay box.
2 CHECK CRUISE SET INDICATOR LIGHT CIRCUIT. 1) Turn the ignition switch to OFF. 2) Disconnect the ECM harness connector. 3) Measure the resistance between ECM harness connector terminal and combination meter harness connector terminal. Connector & terminal Except STI model: <i>(i10) No. 21 — (B135) No. 3:</i> STI model: <i>(i10) No. 21 — (B134) No. 16:</i>	Is the resistance less than 10 Ω ?	Go to step 3.	Repair the harness.
3 CHECK CRUISE SET INDICATOR LIGHT CIRCUIT. 1) Turn the ignition switch to ON. 2) Ground the ECM harness connector terminal with a wire. Connector & terminal Except STI model: <i>(B135) No. 3 — Chassis ground:</i> STI model: <i>(B134) No. 16 — Chassis ground:</i>	Does the cruise set indicator light illuminate?	Check the poor contact of ECM connector.	Replace the meter main assembly.

List of Diagnostic Trouble Code (DTC)

CRUISE CONTROL SYSTEM (DIAGNOSTICS)

7. List of Diagnostic Trouble Code (DTC)

A: LIST

DTC	Item	Contents of diagnosis	Reference
11	Cruise control main switch	Cruise control is released after the cruise control main switch of cruise control switch is turned to OFF.	This DTC is indicated without operating the cruise control main switch. <Ref. to CC(ETC)(diag)-22, DTC 11, 15, 21 AND 24 CRUISE CONTROL COMMAND SWITCH, Diagnostic Procedure with Diagnostic Trouble Code (DTC).>
12	Stop light and brake switch	Cruise control is released after the stop light switch or brake switch is turned to ON.	This DTC is indicated without depressing the brake pedal. <Ref. to CC(ETC)(diag)-25, DTC 12 AND 25 STOP LIGHT SWITCH AND BRAKE SWITCH, Diagnostic Procedure with Diagnostic Trouble Code (DTC).>
13	Clutch switch (MT model)	Cruise control is released after the clutch switch is turned to ON.	This DTC is indicated without depressing the clutch pedal. <Ref. to CC(ETC)(diag)-27, DTC 13 CLUTCH SWITCH, Diagnostic Procedure with Diagnostic Trouble Code (DTC).>
14	Neutral position switch	Cruise control is released after the neutral position switch is turned to ON.	This DTC is indicated without shifting to neutral position. <Ref. to CC(ETC)(diag)-29, DTC 14 NEUTRAL POSITION SWITCH, Diagnostic Procedure with Diagnostic Trouble Code (DTC).>
15	CANCEL switch	Cruise control is released after the CANCEL switch is turned to ON.	This DTC is indicated without operating the CANCEL switch. <Ref. to CC(ETC)(diag)-22, DTC 11, 15, 21 AND 24 CRUISE CONTROL COMMAND SWITCH, Diagnostic Procedure with Diagnostic Trouble Code (DTC).>
16	Ignition switch	Cruise control is released after the ignition switch is turned to OFF.	This DTC is indicated without operating the ignition switch. <Ref. to CC(ETC)(diag)-33, DTC 16 IGNITION SWITCH, Diagnostic Procedure with Diagnostic Trouble Code (DTC).>

List of Diagnostic Trouble Code (DTC)

CRUISE CONTROL SYSTEM (DIAGNOSTICS)

DTC	Item	Contents of diagnosis	Reference
21	Cruise control switch is abnormal when the ignition switch is turned to ON.	Each switch of cruise control command switch has already been ON when the ignition switch is turned to ON.	This DTC is indicated without operating the cruise control main switch. <Ref. to CC(ETC)(diag)-22, DTC 11, 15, 21 AND 24 CRUISE CONTROL COMMAND SWITCH, Diagnostic Procedure with Diagnostic Trouble Code (DTC).>
22	Vehicle speed variation is abnormal.	Abnormality of vehicle speed variation is detected.	<Ref. to CC(ETC)(diag)-35, DTC 22 AND 32 VEHICLE SPEED SENSOR, Diagnostic Procedure with Diagnostic Trouble Code (DTC).>
23	Engine-related sensor is abnormal.	Abnormality related to engine is detected.	H4SO model: <Ref. to EN(H4SO)(diag)-2, Basic Diagnostic Procedure.> STI model: <Ref. to EN(STI)(diag)-2, Basic Diagnostic Procedure.>
24	Cruise control-related switch is abnormal.	Abnormality of cruise control command switch is detected. (Open circuit is detected when continuing to be ON for an extremely long time [approx. two minutes].)	This DTC is indicated with normal operation. <Ref. to CC(ETC)(diag)-22, DTC 11, 15, 21 AND 24 CRUISE CONTROL COMMAND SWITCH, Diagnostic Procedure with Diagnostic Trouble Code (DTC).>
25	Brake switch input circuit is abnormal.	Abnormality of brake switch input circuit in ECM is detected.	<Ref. to CC(ETC)(diag)-25, DTC 12 AND 25 STOP LIGHT SWITCH AND BRAKE SWITCH, Diagnostic Procedure with Diagnostic Trouble Code (DTC).>
31	Engine speed signal.	<ul style="list-style-type: none"> • Abnormal increase of engine speed is detected. • Gear is shifted to neutral, 1st or reverse position. 	Cruise with more than 2nd shift position.
32	Out of vehicle speed range of cruise control operation.	<ul style="list-style-type: none"> • Vehicle speed becomes under the control limit during cruise driving. • Set operation is conducted out of vehicle speed range for setting • RES operation is conducted without vehicle speed memory. 	This DTC is also indicated when increasing the speed to the cruise set available vehicle speed and conducting the set operation again. <Ref. to CC(ETC)(diag)-35, DTC 22 AND 32 VEHICLE SPEED SENSOR, Diagnostic Procedure with Diagnostic Trouble Code (DTC).>

List of Diagnostic Trouble Code (DTC)

CRUISE CONTROL SYSTEM (DIAGNOSTICS)

DTC	Item	Contents of diagnosis	Reference
33	Prohibition of WAIT after acceleration operation.	Vehicle speed becomes over the control limit during cruise driving.	This DTC is indicated when running at the high speed which is not suitable for cruise control. In this case, conduct the cruise set operation again after decreasing the speed to the cruise set available vehicle speed.
34	Prohibition when accelerator position is continued to be large.	Vehicle is driven at the higher speed than set vehicle speed for an extremely long time (approx. 10 minutes) during cruise driving.	This DTC is indicated when running for a long time at the higher speed than cruise set available vehicle speed by accelerator operation. In this case, release the cruise set.
35	Prohibition when vehicle speed feedback is impossible.	During cruise driving, set vehicle speed cannot be maintained for some reasons such as sharp upslope, parking brake and engine output abnormal decrease.	This DTC is indicated when the driving condition is not suitable for cruise control. Conduct the cruise set operation again after clearing the estimated reasons.

8. Diagnostic Procedure with Diagnostic Trouble Code (DTC)

A: DTC 11, 15, 21 AND 24 CRUISE CONTROL COMMAND SWITCH

TROUBLE SYMPTOM:

- Cruise control cannot be set. (Cancelled immediately.)
- Cruise control cannot be released.

WIRING DIAGRAM:

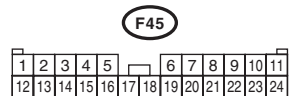
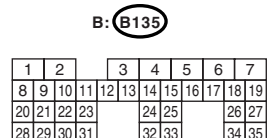
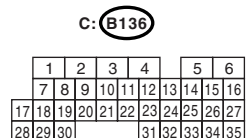
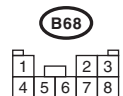
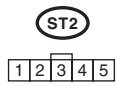
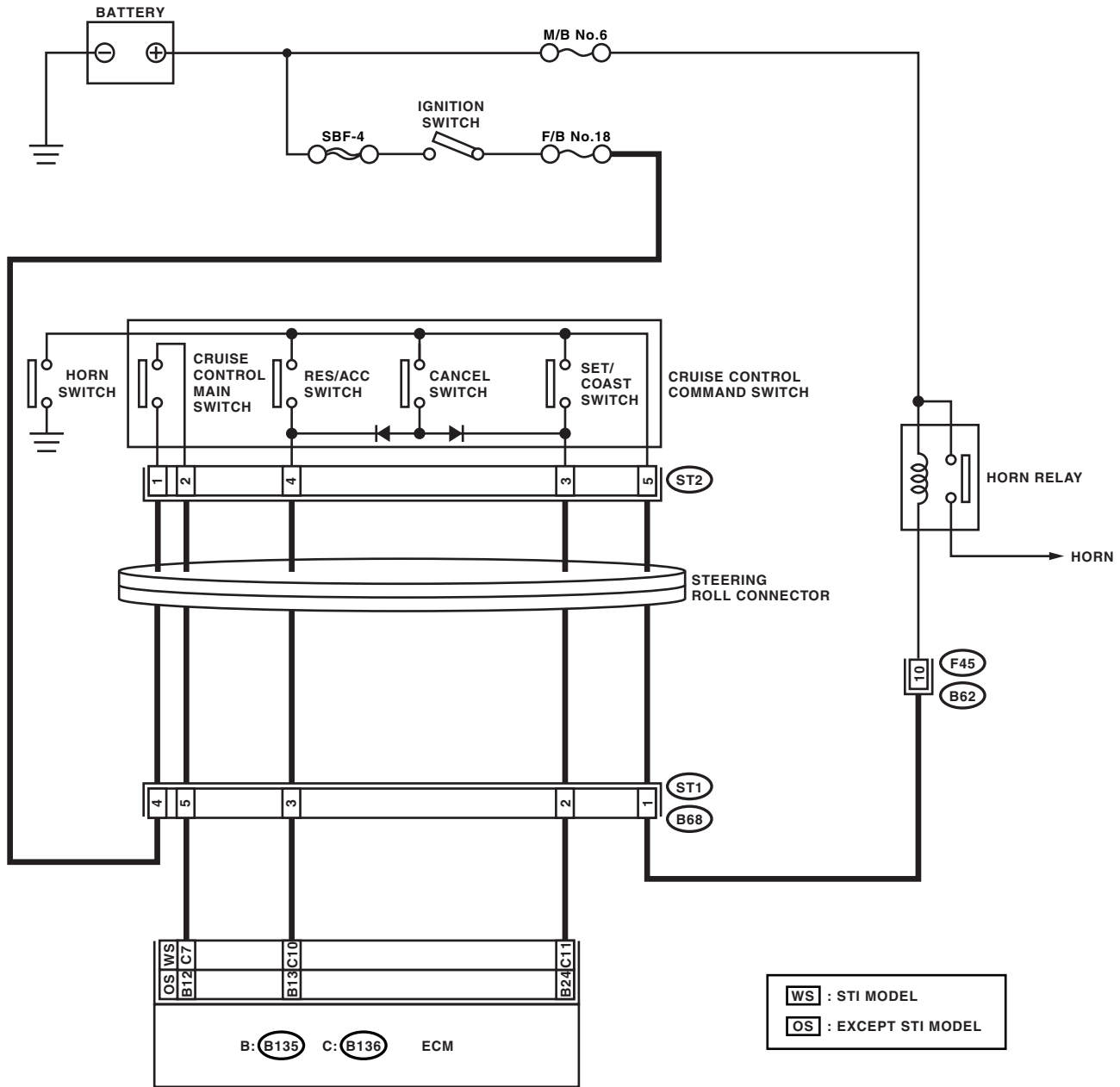

Diagnostic Procedure with Diagnostic Trouble Code (DTC)

CRUISE CONTROL SYSTEM (DIAGNOSTICS)

Step	Check	Yes	No
1 CHECK CRUISE CONTROL MAIN SWITCH CIRCUIT. 1) Turn the ignition switch to OFF. 2) Disconnect the ECM harness connector. 3) Turn the ignition switch to ON. 4) Measure the voltage between harness connector terminal and chassis ground when the cruise control main switch is pressed and is not pressed. Connector & terminal Except STI model: (B135) No. 12 (+) — Chassis ground (-); STI model: (B136) No. 7 (+) — Chassis ground (-);	Is the voltage 0 V when the cruise control main switch is not pressed? Is the voltage more than 10 V when the cruise control main switch is pressed?	Go to step 2.	<ul style="list-style-type: none"> • Check the fuse No. 18 (in fuse & relay box). • Check the harness for open or short between cruise control command switch and fuse & relay box. If no malfunction is found after checking above, Go to step 6.
2 CHECK SET/COAST SWITCH CIRCUIT. 1) Turn the ignition switch to OFF. 2) Disconnect the ECM harness connector. 3) Measure the voltage between harness connector terminal and chassis ground when SET/COAST switch is pressed and not pressed. Connector & terminal Except STI model: (B135) No. 24 (+) — Chassis ground (-); STI model: (B136) No. 11 (+) — Chassis ground (-);	Is the voltage 0 V when SET/COAST switch is not pressed? Is the voltage more than 10 V when SET/COAST switch is pressed?	Go to step 3.	Go to step 5.
3 CHECK RES/ACC SWITCH CIRCUIT. Measure the voltage between harness connector terminal and chassis ground when RES/ACC switch is pressed and not pressed. Connector & terminal Except STI model: (B135) No. 13 (+) — Chassis ground (-); STI model: (B136) No. 10 (+) — Chassis ground (-);	Is the voltage 0 V when RES/ACC switch is not pressed? Is the voltage more than 10 V when RES/ACC switch is pressed?	Go to step 4.	Go to step 5.
4 CHECK CANCEL SWITCH CIRCUIT. Measure the voltage between harness connector terminal and chassis ground when CANCEL switch is pressed and not pressed. Connector & terminal Except STI model: (B135) No. 13 (+) — Chassis ground (-); (B135) No. 24 (+) — Chassis ground (-); STI model: (B136) No. 10 (+) — Chassis ground (-); (B136) No. 11 (+) — Chassis ground (-);	Is the voltage 0 V when CANCEL switch is not pressed? Is the voltage more than 10 V when CANCEL switch is pressed?	Cruise control command switch circuit is OK.	Go to step 5.

Diagnostic Procedure with Diagnostic Trouble Code (DTC)

CRUISE CONTROL SYSTEM (DIAGNOSTICS)

Step	Check	Yes	No
5	CHECK POWER SUPPLY FOR CRUISE CONTROL COMMAND SWITCH. Check the horn operation.	Does the horn sound?	Go to step 6. <ul style="list-style-type: none">• Check the fuse No. 6 (in main fuse box).• Check the horn relay. <Ref. to COM-3, HORN RELAY, INSPECTION, Horn System.>• Check the harness for open or short between cruise control command switch and fuse & relay box.
6	CHECK CRUISE CONTROL COMMAND SWITCH. Remove and check the cruise control switch. <Ref. to CC-7, Cruise Control Command Switch.>	Is the cruise control command switch OK?	Check the harness between cruise control command switch and ECM. Replace the cruise control command switch.

Diagnostic Procedure with Diagnostic Trouble Code (DTC)

CRUISE CONTROL SYSTEM (DIAGNOSTICS)

B: DTC 12 AND 25 STOP LIGHT SWITCH AND BRAKE SWITCH

TROUBLE SYMPTOM:

- Cruise control cannot be set.
- Cruise control cannot be released.

WIRING DIAGRAM:

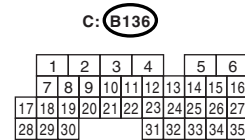
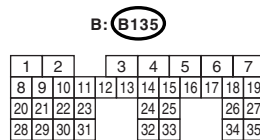
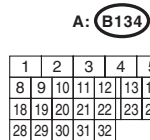
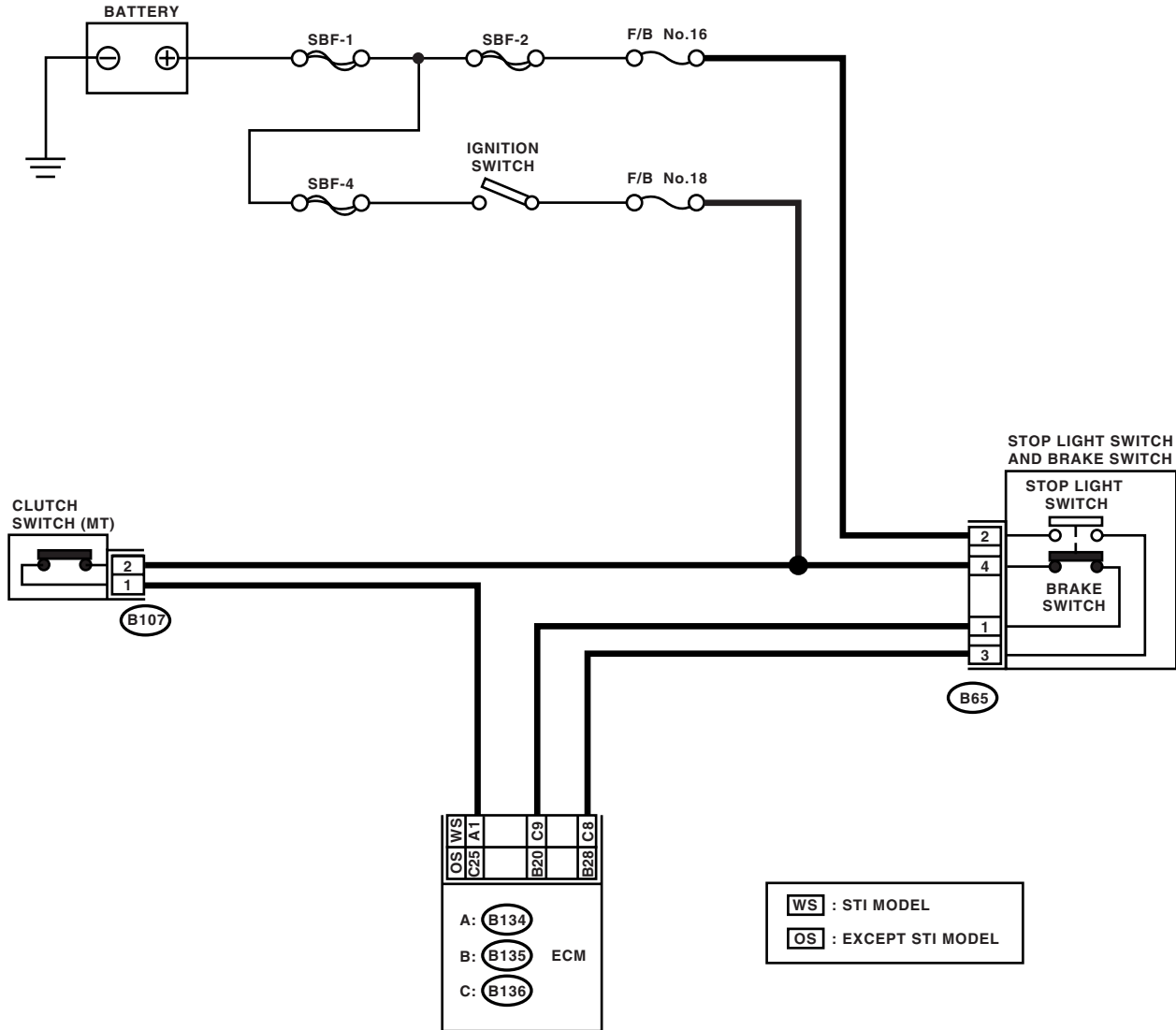

CC-00412

Diagnostic Procedure with Diagnostic Trouble Code (DTC)

CRUISE CONTROL SYSTEM (DIAGNOSTICS)

Step	Check	Yes	No
1 CHECK STOP LIGHT AND BRAKE SWITCH CIRCUIT. 1) Turn the ignition switch to OFF. 2) Disconnect the stop light and brake switch harness connector. 3) Turn the ignition switch to ON. 4) Measure the voltage between harness connector terminal and chassis ground. <i>Connector & terminal</i> <i>(B65) No. 2 (+) — Chassis ground (-):</i>	Is the voltage more than 10 V?	Go to step 2.	<ul style="list-style-type: none"> • Check the fuse No. 16 (in fuse & relay box). • Check the harness for open or short between stop light and brake switch and fuse & relay box.
2 CHECK STOP LIGHT AND BRAKE SWITCH CIRCUIT. Measure the voltage between harness connector terminal and chassis ground. <i>Connector & terminal</i> <i>(B65) No. 4 (+) — Chassis ground (-):</i>	Is the voltage more than 10 V?	Go to step 3.	<ul style="list-style-type: none"> • Check the fuse No. 18 (in fuse & relay box). • Check the harness for open or short between stop light and brake switch and fuse & relay box. • Check the clutch switch and circuit.
3 CHECK STOP LIGHT AND BRAKE SWITCH CIRCUIT. 1) Turn the ignition switch to OFF. 2) Disconnect the ECM harness connector. 3) Measure the resistance between ECM harness connector terminal and stop light and brake switch harness connector terminal. <i>Connector & terminal</i> <i>Except STI model:</i> <i>(B135) No. 28 — (B65) No. 3:</i> <i>(B135) No. 20 — (B65) No. 1:</i> <i>STI model:</i> <i>(B136) No. 8 — (B65) No. 3:</i> <i>(B136) No. 9 — (B65) No. 1:</i>	Is the resistance less than 10 Ω ?	Go to step 4.	Repair the harness.
4 CHECK STOP LIGHT AND BRAKE SWITCH. Remove and check the stop light switch and brake switch. <Ref. to CC-8, Stop Light and Brake Switch.>	Are the stop light and brake switch OK?	Stop light and brake switch circuit are OK.	Replace the stop light and brake switch.

Diagnostic Procedure with Diagnostic Trouble Code (DTC)

CRUISE CONTROL SYSTEM (DIAGNOSTICS)

C: DTC 13 CLUTCH SWITCH

TROUBLE SYMPTOM:

- Cruise control cannot be set.
- Cruise control cannot be released.

WIRING DIAGRAM:

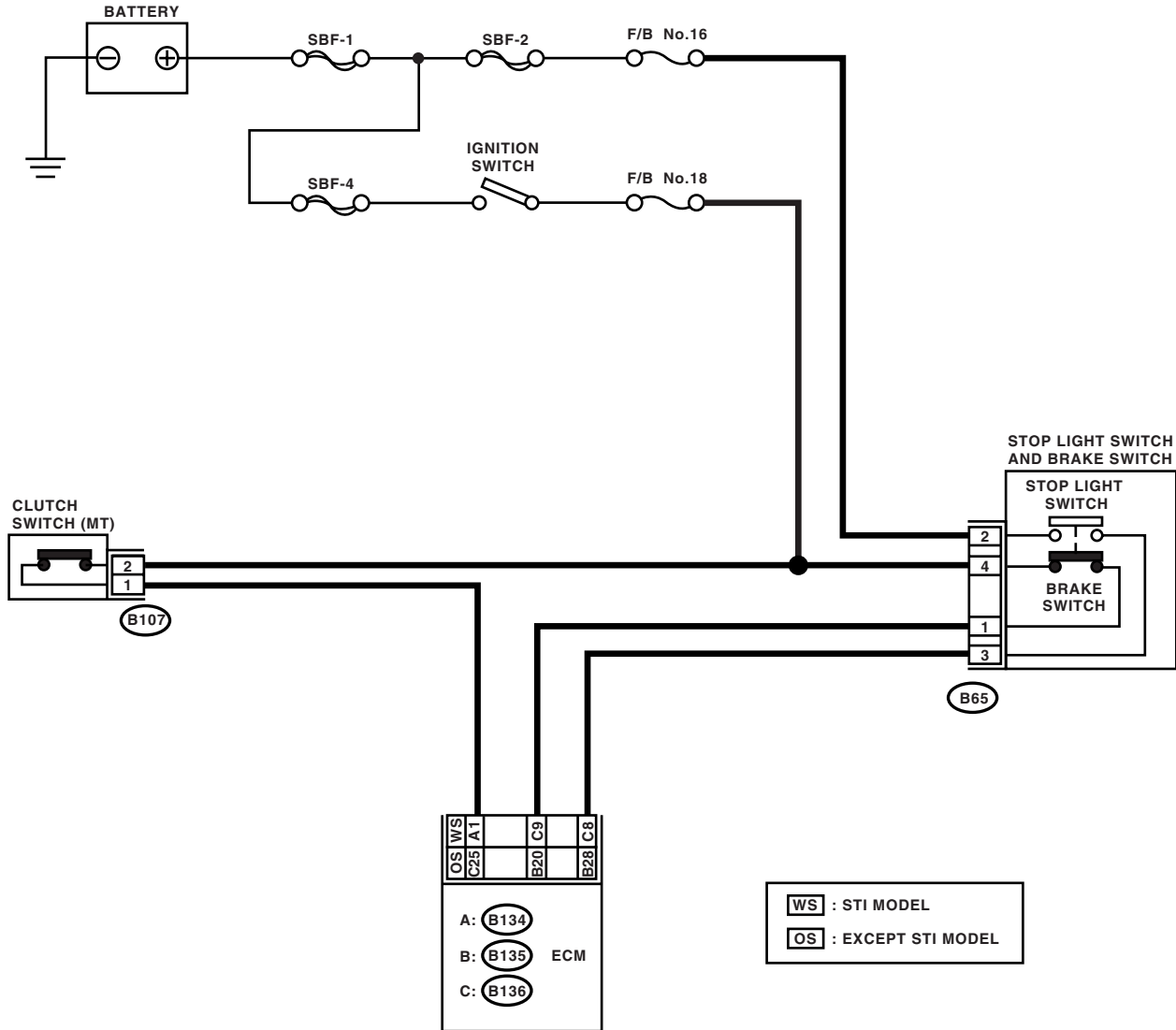

B107



B65



A: B134



B: B135

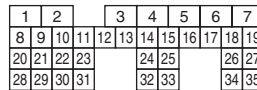

C: B136

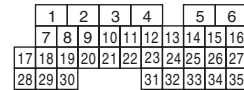

CC-00412

Diagnostic Procedure with Diagnostic Trouble Code (DTC)

CRUISE CONTROL SYSTEM (DIAGNOSTICS)

Step	Check	Yes	No
1 CHECK CLUTCH SWITCH CIRCUIT. 1) Turn the ignition switch to OFF. 2) Disconnect the clutch switch harness connector. 3) Turn the ignition switch to ON. 4) Measure the voltage between harness connector terminal and chassis ground. Connector & terminal (B107) No. 2 (+) — Chassis ground (-):	Is the voltage more than 10 V?	Go to step 2.	<ul style="list-style-type: none"> • Check the fuse No. 18 (fuse & relay box). • Check the harness for open or short between clutch switch and fuse & relay box.
2 CHECK CLUTCH SWITCH CIRCUIT. 1) Turn the ignition switch to OFF. 2) Disconnect the ECM harness connector. 3) Measure the resistance between clutch switch harness connector terminal and ECM harness connector terminal. Connector & terminal Except STI model: (B107) No. 1 — (B136) No. 25: STI model: (B107) No. 1 — (B134) No. 1:	Is the resistance less than 10 Ω ?	Go to step 3.	Repair the harness.
3 CHECK CLUTCH SWITCH. Remove and check the clutch switch. <Ref. to CC-9, Clutch Switch.>	Is the clutch switch OK?	Clutch switch circuit is OK.	Replace the clutch switch.

Diagnostic Procedure with Diagnostic Trouble Code (DTC)

CRUISE CONTROL SYSTEM (DIAGNOSTICS)

D: DTC 14 NEUTRAL POSITION SWITCH

TROUBLE SYMPTOM:

Cruise control cannot be set.

WIRING DIAGRAM:

- Non-turbo model

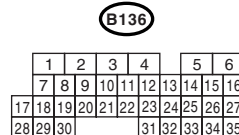
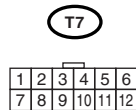
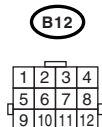
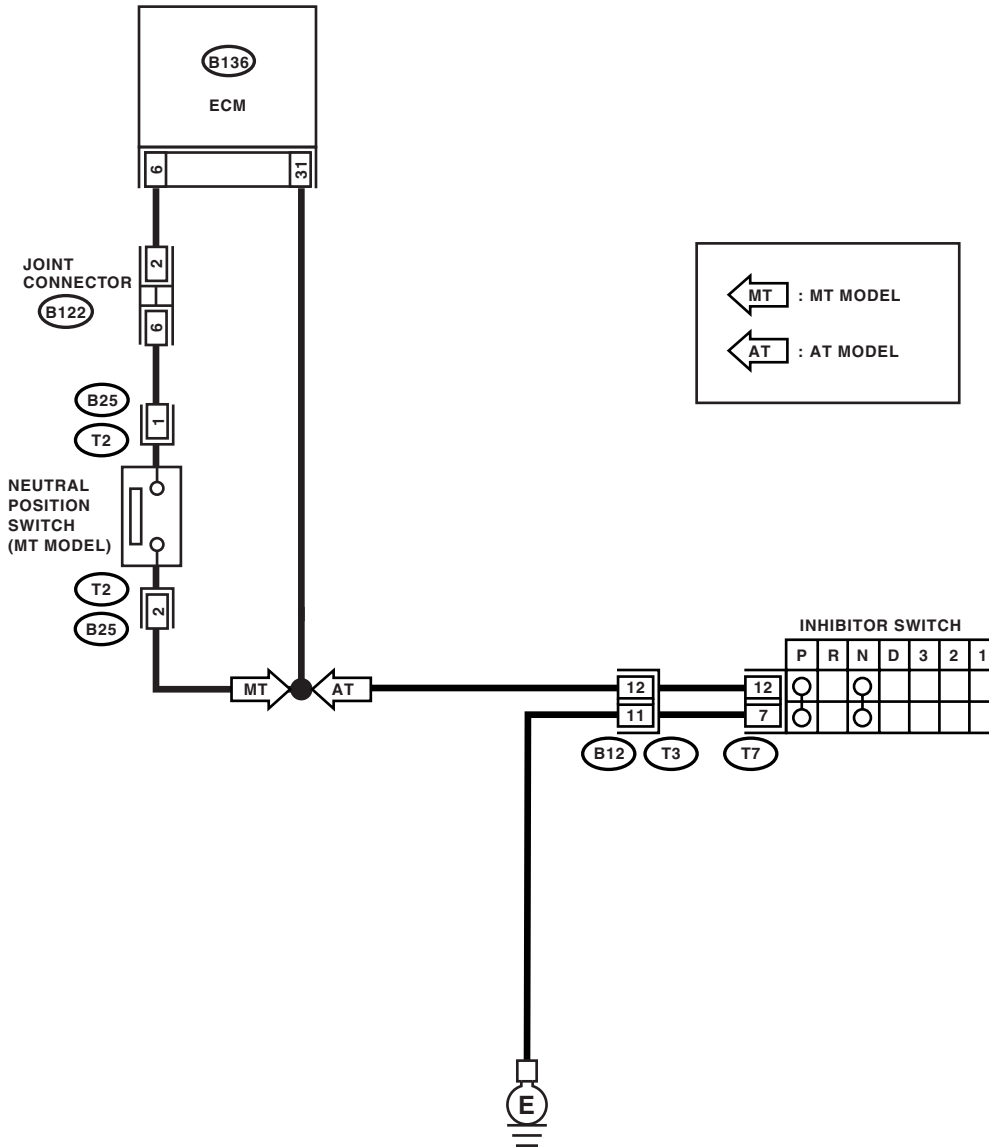

CC-00443

Diagnostic Procedure with Diagnostic Trouble Code (DTC)

CRUISE CONTROL SYSTEM (DIAGNOSTICS)

- Turbo model

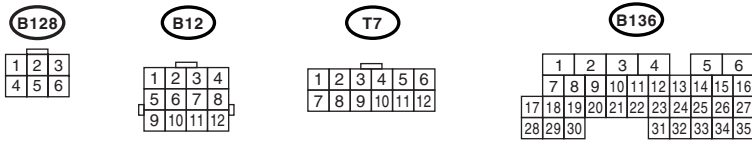
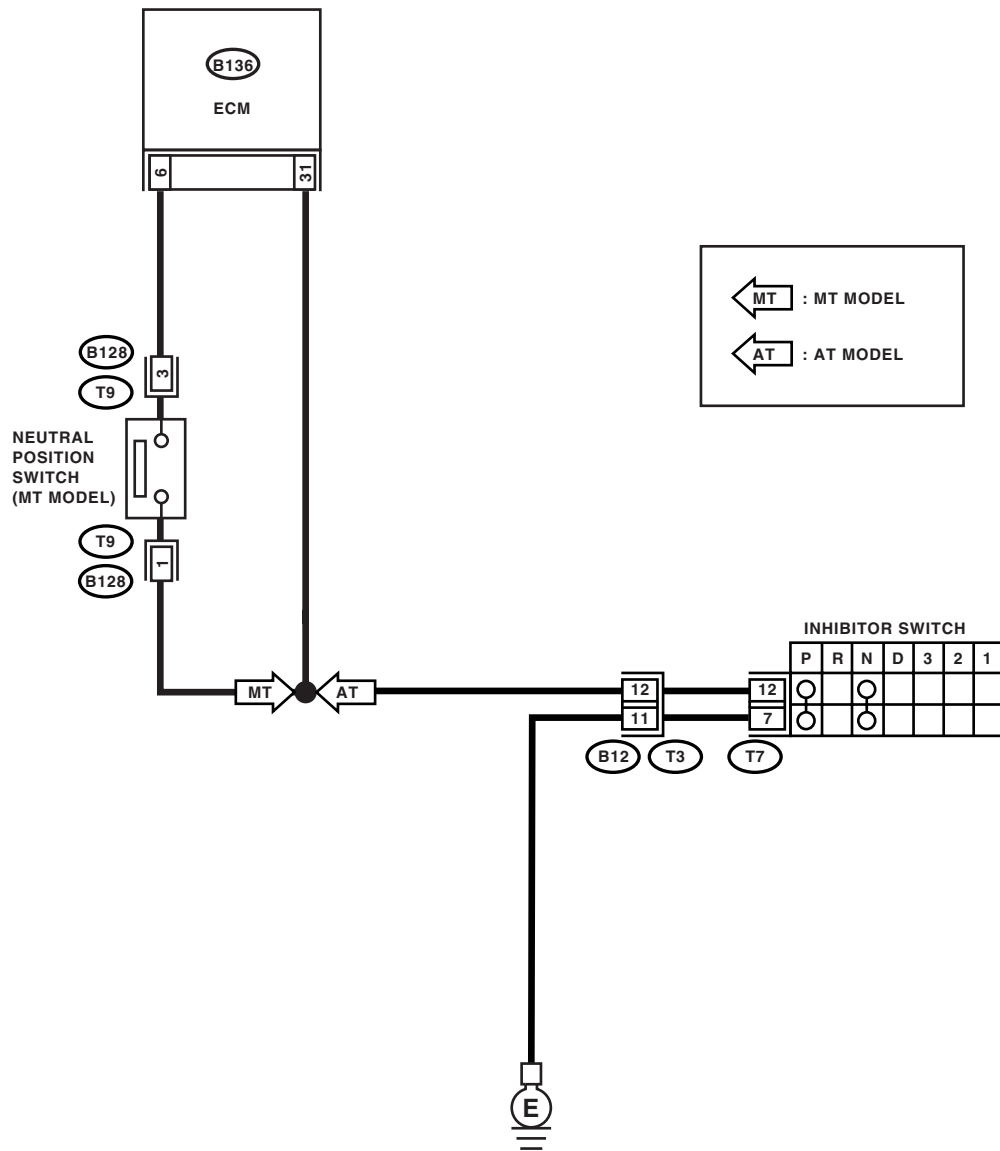

CC-00444

Diagnostic Procedure with Diagnostic Trouble Code (DTC)

CRUISE CONTROL SYSTEM (DIAGNOSTICS)

- STI model

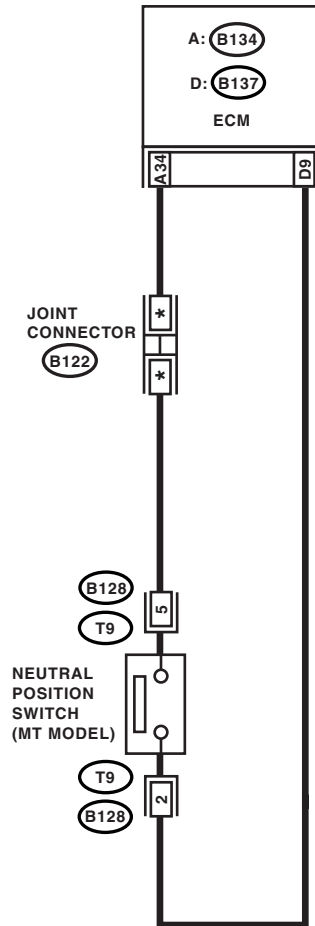

* : TERMINAL No. RANDOM ARRANGEMENT

B128

1	2	3
4	5	6

B122

1	2	3
4	5	6

A: B134

1	2	3	4	5	6	7			
8	9	10	11	12	13	14	15	16	17
18	19	20	21	22	23	24	25	26	27
28	29	30	31	32			33	34	

D: B137

1	2	3	4	5	6	7			
8	9	10	11	12	13	14	15	16	17
18	19	20	21	22	23		24	25	
26	27			28	29		30	31	

CC-00445

Diagnostic Procedure with Diagnostic Trouble Code (DTC)

CRUISE CONTROL SYSTEM (DIAGNOSTICS)

Step	Check	Yes	No
1	CHECK TRANSMISSION TYPE.	Go to step 2.	Go to step 5.
2	CHECK INHIBITOR SWITCH CIRCUIT. 1) Turn the ignition switch to OFF. 2) Disconnect the inhibitor switch harness connector. 3) Turn the ignition switch to ON. 4) Measure the voltage between harness connector terminal and chassis ground. Connector & terminal (T7) No. 12 (+) — Chassis ground (-):	Go to step 3.	Check the harness for open or short between inhibitor switch and ECM.
3	CHECK INHIBITOR SWITCH CIRCUIT. 1) Turn the ignition switch to OFF. 2) Disconnect the starter motor harness connector. 3) Measure the resistance between inhibitor switch harness connector terminal and chassis ground. Connector & terminal (T7) No. 7 — Chassis ground:	Repair the harness.	Go to step 4.
4	CHECK INHIBITOR SWITCH. Remove and check the inhibitor switch. <Ref. to CC-10, Inhibitor Switch.>	Replace the ECM. <Ref. to FU(H4SO)-38, Engine Control Module (ECM).>	Replace the inhibitor switch.
5	CHECK NEUTRAL POSITION SWITCH CIRCUIT. 1) Turn the ignition switch to OFF. 2) Disconnect the neutral position switch harness connector. 3) Turn the ignition switch to ON. 4) Measure the voltage between harness connector terminal and chassis ground. Connector & terminal Non-turbo model: (B25) No. 1 (+) — Chassis ground (-): Turbo model: (B128) No. 1 (+) — Chassis ground (-): STI model: (B128) No. 2 (+) — Chassis ground (-):	Go to step 6.	Check the harness for open or short between neutral position switch and ECM.
6	CHECK NEUTRAL POSITION SWITCH CIRCUIT. 1) Turn the ignition switch to OFF. 2) Measure the resistance between neutral position switch harness connector terminal and chassis ground. Connector & terminal Non-turbo model: (B25) No. 2 — Chassis ground: Turbo model: (B128) No. 3 — Chassis ground: STI model: (B128) No. 5 — Chassis ground:	Go to step 7.	Repair the harness.
7	CHECK NEUTRAL POSITION SWITCH. Remove and check the neutral position switch. <Ref. to CC-11, Neutral Position Switch.>	Neutral position switch circuit is OK.	Replace the neutral position switch.

Diagnostic Procedure with Diagnostic Trouble Code (DTC)

CRUISE CONTROL SYSTEM (DIAGNOSTICS)

E: DTC 16 IGNITION SWITCH

TROUBLE SYMPTOM:

Cruise control cannot be set.

WIRING DIAGRAM:

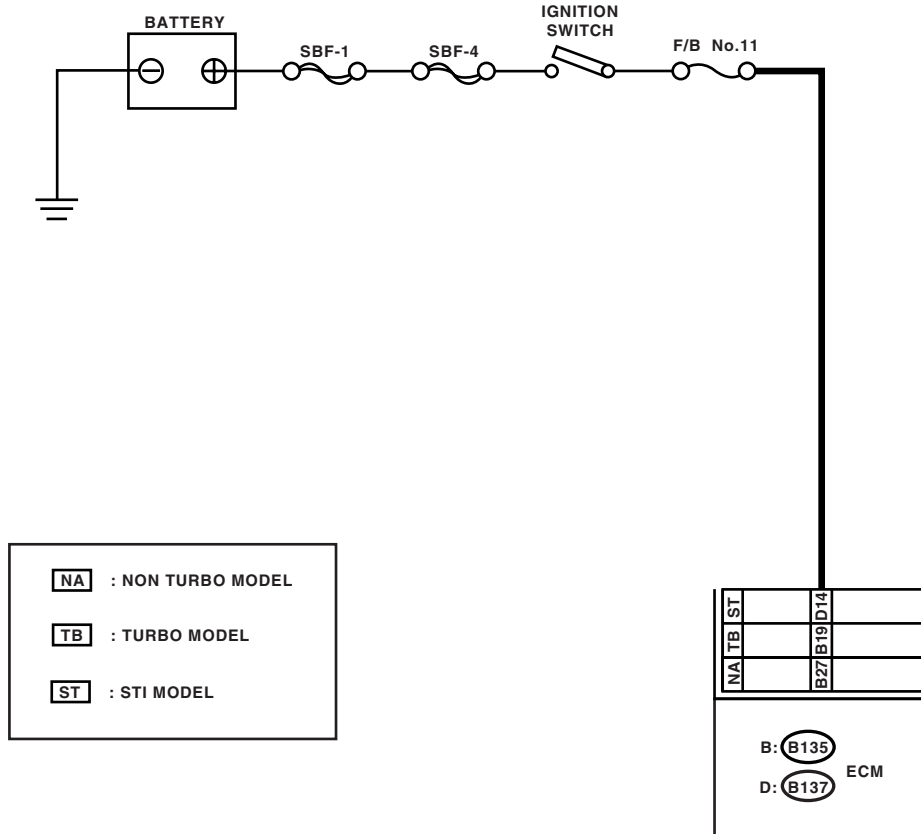

D: B137

1	2	3	4	5	6	7
8	9	10	11	12	13	14
15	16	17	18	19	20	21
22	23	24	25	26	27	28
29	30	31				

B: B135

1	2	3	4	5	6	7
8	9	10	11	12	13	14
15	16	17	18	19	20	21
22	23	24	25	26	27	28
29	30	31	32	33	34	35

CC-00414

Diagnostic Procedure with Diagnostic Trouble Code (DTC)

CRUISE CONTROL SYSTEM (DIAGNOSTICS)

Step	Check	Yes	No
<p>1 CHECK IGNITION SWITCH CIRCUIT. 1) Turn the ignition switch to OFF. 2) Disconnect the ECM harness connector. 3) Turn the ignition switch to ON. 4) Measure the voltage between harness connector terminal and chassis ground.</p> <p>Connector & terminal Non-turbo model: <i>(B135) No. 27 (+) — Chassis ground (-):</i> Turbo model: <i>(B135) No. 19 (+) — Chassis ground (-):</i> STI model: <i>(B137) No. 14 (+) — Chassis ground (-):</i></p>	Is the voltage more than 10 V?	Check the poor contact of ECM connector.	<ul style="list-style-type: none">• Check the fuse No. 11 (fuse & relay box).• Check the harness for open or short between ignition switch and ECM.

Diagnostic Procedure with Diagnostic Trouble Code (DTC)

CRUISE CONTROL SYSTEM (DIAGNOSTICS)

F: DTC 22 AND 32 VEHICLE SPEED SENSOR

DIAGNOSIS:

Open or short circuit of vehicle speed sensor system.

TROUBLE SYMPTOM:

Cruise control cannot be set. (Cancelled immediately.)

WIRING DIAGRAM:

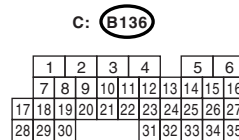
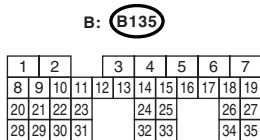
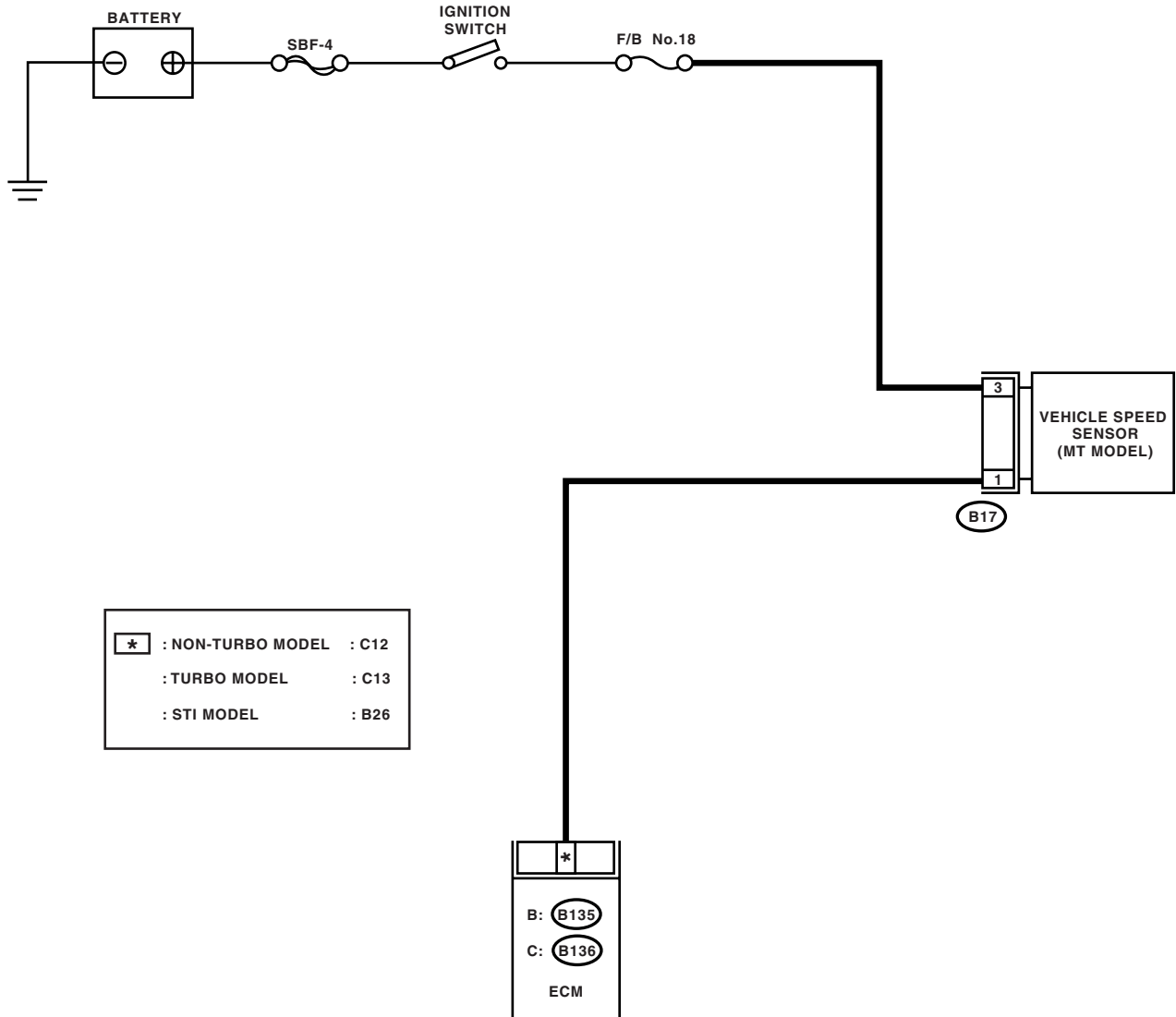

CC-00388

Diagnostic Procedure with Diagnostic Trouble Code (DTC)

CRUISE CONTROL SYSTEM (DIAGNOSTICS)

Step	Check	Yes	No
1 CHECK HARNESS BETWEEN BATTERY AND VEHICLE SPEED SENSOR. 1) Turn the ignition switch to OFF. 2) Disconnect the harness connector from vehicle speed sensor. 3) Turn the ignition switch to ON. 4) Measure the voltage between vehicle speed sensor harness connector terminal and chassis ground. Connector & terminal (B17) No. 3 (+) — Chassis ground (-):	Is the voltage more than 10 V?	Go to step 2.	Check the harness for open or short between fuse and vehicle speed sensor.
2 CHECK HARNESS BETWEEN ECM AND VEHICLE SPEED SENSOR. 1) Turn the ignition switch to OFF. 2) Disconnect the harness connector from ECM. 3) Measure the resistance between vehicle speed sensor harness connector terminal and ECM harness connector terminal. Connector & terminal (B17) No. 1 — (B135) No. 27:	Is the resistance less than 10 Ω ?	Go to step 3.	Repair the harness.
3 CHECK HARNESS BETWEEN VEHICLE SPEED SENSOR AND ENGINE GROUND. 1) Turn the ignition switch to OFF. 2) Measure the resistance between vehicle speed sensor harness connector terminal and engine ground. Connector & terminal (B17) No. 2 — Engine ground:	Is the resistance less than 10 Ω ?	Go to step 4.	Repair the harness.
4 CHECK VEHICLE SPEED SENSOR. 1) Connect the harness connector to vehicle speed sensor. 2) Lift-up the vehicle. 3) Drive the vehicle at speed greater than 20 km/h (12 MPH). Warning: Be careful not to be caught up by the running wheels. 4) Measure the voltage between ECM harness connector terminal and chassis ground. Connector & terminal (B135) No. 27 (+) — Chassis ground (-):	Is the voltage less than 1 V ←→ more than 5 V?	Check the poor contact of ECM connector.	Replace the vehicle speed sensor.